

TX 12/35

THE RAISING POWER



TX

The TX series stackers are characterized by manual traction and electrohydraulic lifting technology. These stackers are very steady and are suitable for lifting very heavy loads safely. Version 12 (1.2 t) includes polyurethane wheels as standard to reduce resistance and effort required even with full load capacity.



START KEY AND BATTERY CUT-OFF (ISOLATOR) SWITCH

The start key on the TX stacker performs a double function:

- switches the stacker on/off;
- is an emergency control, i.e. it completely stops battery power supply and thus prevents the lifting of forks.



FOOT BRAKE

The foot brake performs the parking brake function.



TILLER

The ergonomic tiller allows an excellent directionality of the machine, thanks to a steering system on both rear wheels.



ADJUSTABLE BUFFERS

The TX 12 version is equipped with adjustable buffers that minimize possible oscillation during lifting.



PROTECTIVE COVER

It allows an easier access to the battery housing for faster ordinary maintenance.



Description

1.1 Manufacturer			LIFTER
1.3 Drive			Manual
1.4 Operator type			Pedestrian
1.5 Load capacity	Q	Kg	1200
1.6 Load centre distance	c	mm	600
1.8 Load axle to end forks	x	mm	780
1.9 Wheel base	y	mm	1155

Weights

2.1 Service weight (battery included)		Kg	474
2.2 Axle load, laden rear		Kg	1137
2.2 Axle load, laden front		Kg	537
2.3 Axle load, unladen front		Kg	345
2.3 Axle load, unladen rear		Kg	129

Tyres/Chassis

3.1 Tyres: stabilizers wheels - front			POLY.C.
3.1 Tyres: rear wheels			NYLON
3.3 Tyre size: Load rollers - Diameter		mm	82
3.3 Tyre size: Load rollers - Width		mm	70
3.4 Tyre size: stabilizers wheels front - Diameter		mm	200
3.4 Tyre size: stabilizers wheels front - Width		mm	50
3.5 Tyre size: rear wheels - Q.ty (X=driven)		nr	2
3.6 Tread, front	b10	mm	720
3.7 Tread, rear	b11	mm	410

Dimensions

4.2 Height, mast lowered	h1	mm	2250
4.3 Normal free lifting	h2	mm	80
4.4 Lift height	h3	mm	3410
4.5 Height, mast extended	h4	mm	3915
4.9 Height of tiller in drive position max	h14	mm	1080
4.15 Height, lowered	h13	mm	90
4.19 Overall length	l1	mm	1850
4.20 Length to face of forks	l2	mm	700
4.21 Overall width	b1	mm	850
4.22 Fork dimensions - Thickness	s	mm	70
4.22 Fork dimensions - Width	e	mm	150
4.22 Fork dimensions - Length	l	mm	1150
4.24 Fork carriage width	b3	mm	650
4.25 Distance between fork arms	b5	mm	560
4.32 Ground clearance, centre of wheelbase	m2	mm	20
4.34 Aisle width	Ast	mm	2540
4.35 Turning radius	Wa	mm	1760

Performance data

5.2 Lifting speed laden	m/s	0.09
5.2 Lifting speed unladen	m/s	0.12
5.3 Lowering speed laden	m/s	0.4
5.3 Lowering speed unladen	m/s	0.1

Electric motors

6.2 Lift motor power	kW	2.2
6.4 Battery voltage	V	24
6.4 Battery capacity, Min	Ah	74
6.4 Battery capacity, Max	Ah	74
6.5 Battery weight, Min	Kg	36
6.5 Battery weight, Max	Kg	36
8.4 Sound level at driver's ear	dB(A)	67

Residual lifting capacity

Lifting height (H3) 2500 mm	Kg	1200
Lifting height (H3) 2900 mm	Kg	800
Lifting height (H3) 3500 mm	Kg	600

Battery and battery charger integrated

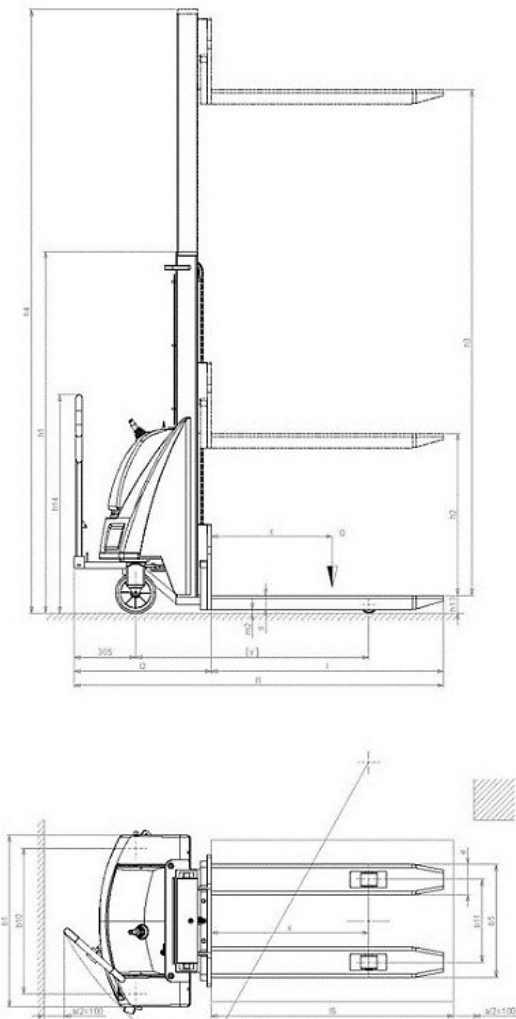

The information is aligned with the Data file at the time of download. Printed on 12/10/2021 (ID 641)

©2021 | PR INDUSTRIAL s.r.l. | All rights reserved | Image shown may not reflect actual package. Specifications subject to change without notice

